

Part Number	Description
LPD60a	250mA, 28Vdc dual solid-state relay

MECHANICAL SPECIFICATION

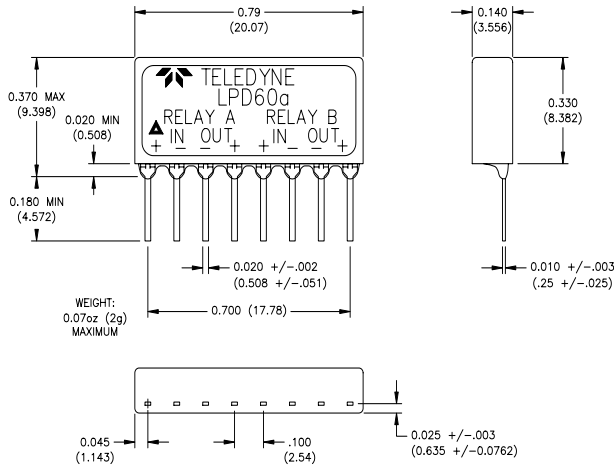
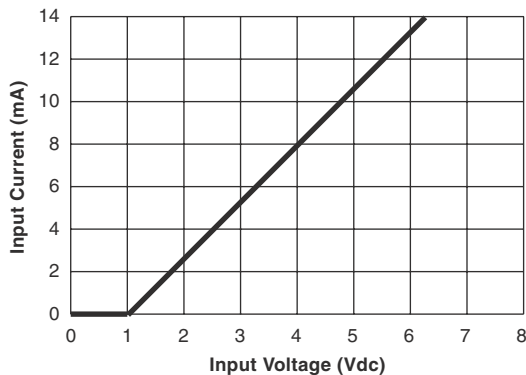

Figure 1 – LPD60a relay; dimensions in inches (mm)
Tolerances are +/- .005 inch (.127) unless otherwise specified

INPUT (CONTROL) SPECIFICATIONS
(-40 to 85°C)

	Min	Max	Units
Control Voltage Range (See Note 1)	4.0	7.0	Vdc
Input Current @ 5 Vdc (See Fig 2)		12	mA
Must Turn-On Voltage	4		Vdc
Must Turn-Off Voltage		0.8	Vdc
Must Turn-Off Current		50	µA
Reverse Voltage	-7		Vdc



INPUT CURRENT VS. INPUT VOLTAGE

Figure 2



FEATURES/BENEFITS

- Current limiting output
- Thermal protection
- Automatic recovery
- Overload protection
- Dual output: Two relays in one package
- Low voltage drop

DESCRIPTION

The LPD60a is a dual-output 28Vdc plastic relay with internal thermal protection. The relay utilizes optical isolation to provide excellent input-to-output isolation. The LPD60a offers a current limiting output to protect itself and associated load circuits from transient current overloads. During an overcurrent condition, the LPD60a clamps the current to a safe operating value. The LPD60a also offers thermal protection. The thermal protection is activated by junction temperature. In case of an overload or shorted load condition, the thermal protection limits the junction temperature. The LPD60a returns to normal operation automatically once the overload is removed.

OUTPUT (LOAD) SPECIFICATIONS

	Min	Max	Units
Load Voltage Rating		33	Vdc
Load Current (See Fig 6)		0.25	A
Transient Voltage		80	Vdc
Transient Supply Voltage with Load shorted (5 sec max)		46	Vdc
Output Capacitance @ 25Vdc		200	pF
On-State Voltage Drop (See Fig 4)		0.5	Vdc
On Resistance		2.0	Ohm
Off-State Leakage Current (33Vdc)		10	µA
Turn-On Time		2.5	ms
Turn-Off Time		1	ms
Overload Current Limit (See Fig 5)		0.9	A

OVERLOAD/THERMAL PROTECTION SPECIFICATIONS (NOTE 8)

	Min	Typical	Max	Units
Output Load Voltage			33	Vdc
Junction Activation Temperature		150		°C
Output Current (after 120 sec)		60		mArms
Activation Time (See Fig. 7, Note7)		70		ms

ENVIRONMENTAL SPECIFICATIONS

	Min	Max	Units
Operating Temperature	-40	+85	°C
Storage Temperature	-55	+100	°C
Junction Temperature		100	°C
Thermal Resistance (Junction to Ambient) each relay		120	°C/W
Shock		1500	g
Vibration		100	g
Dielectric Strength	500		Vac
Insulation Resistance (@500 Vdc)	10 ⁹		Ohm
Isolation		5	pF
Resistance to Soldering Heat	Solder Dip, 10 seconds at +260°C MIL STD 202, method 210		
Solderability	MIL STD 202, method 208		
Thermal Shock	MIL STD 202, method 107		
HAST	JEDEC Test Method A110 130°C 85% RH, no power applied, 50 hours		

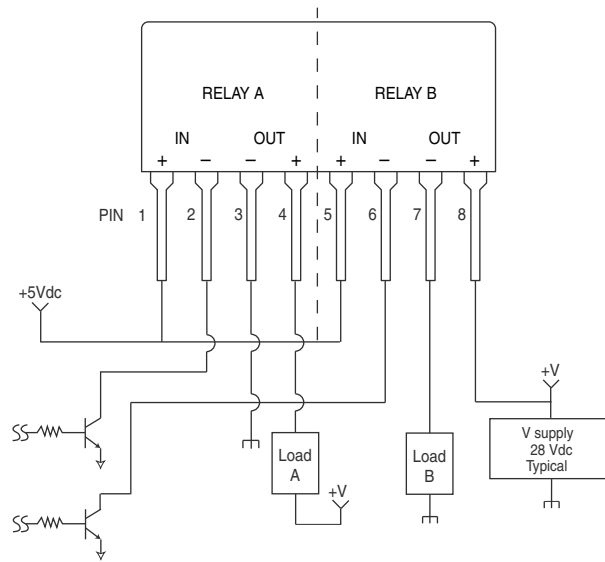

TYPICAL WIRING DIAGRAM

Figure 3

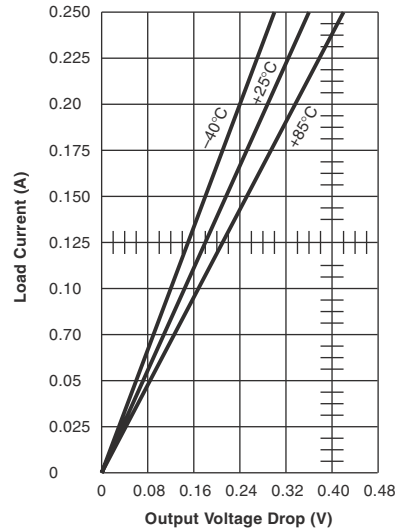

LOAD CURRENT VS. OUTPUT VOLTAGE DROP OVER TEMPERATURE

Figure 4

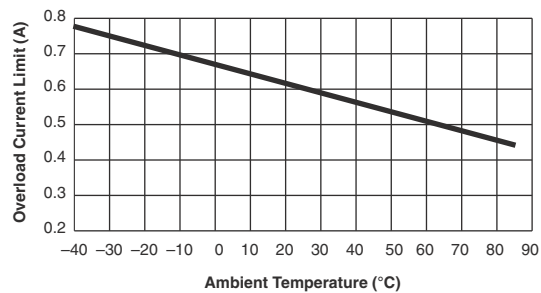

TYPICAL OVERLOAD CURRENT VS. TEMPERATURE

Figure 5

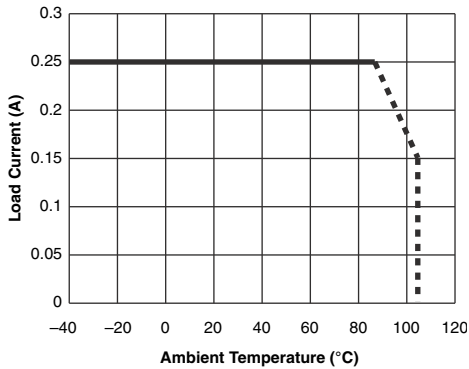

LOAD CURRENT VS. AMBIENT TEMPERATURE

Figure 6

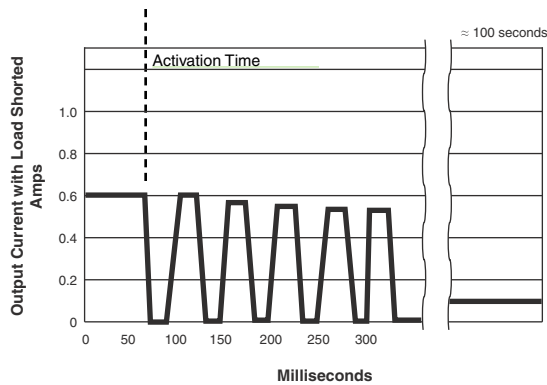

TYPICAL OVERLOAD CURRENT VS. TIME

Figure 7

THEORY OF OPERATION

LPD60a relays operate with 0.25 amp loads from -40° to +85°C. Overloads are current-limited to about 0.6 amps. A temperature sense circuit in intimate contact with the output power switch opens the switch at elevated junction temperatures. This thermal shutdown results in a periodic cycling of the output switch, with the overload current decaying over time. Once the overload is removed, the relay returns to normal operation. The LPD60a relay survives overloads, including shorted loads, at load voltages up to 33Vdc.

NOTES

- For input voltages greater than 7 volts, use an external resistor in series with the relay input. $R_{ext} = (V_{in} - 7 \text{ Vdc}) / 0.012 \text{ Amps}$
- Relay input voltage transitions should be less than 1.0 millisecond.
- Above approximately 0.6 Amps load (overload), the relay becomes current limited. In this mode of operation, the voltage across the relay contacts is: $V_{contact} \cong V_{supply} - [(0.6 \text{ Amp}) (R_{load})]$
The relay will limit current in an overload condition until the overload is removed.
- Maximum load current ratings are with the relay in free air and soldered to a printed circuit board.
- Loads may be attached to either the positive or negative output terminal.
- Timing is measured from the input voltage transition to the 10% or 90% points on the output voltage transition.
- Activation time is the time for the thermal protection circuit to take effect.
- The LPD60a relay withstands shorted Loads at 33 Vdc Max supply voltage indefinitely, and survives shorted load conditions at 46 Vdc Max Supply Voltage for 5 seconds Max.

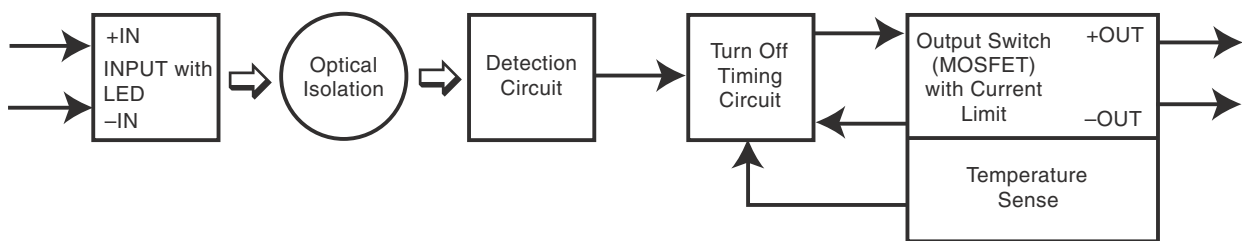

FUNCTIONAL BLOCK DIAGRAM

Figure 8